

WiCloud

COD. 1121A.2/1121A.6

FORZA 200 N - CORSA MASSIMA 210 MM
ALIMENTAZIONE ELETTRICA: 24V $\overline{=}$ (DC)

FORCE 200 N - MAXIMUM STROKE 210 MM
ELECTRIC POWER SUPPLY: 24V $\overline{=}$ (DC)

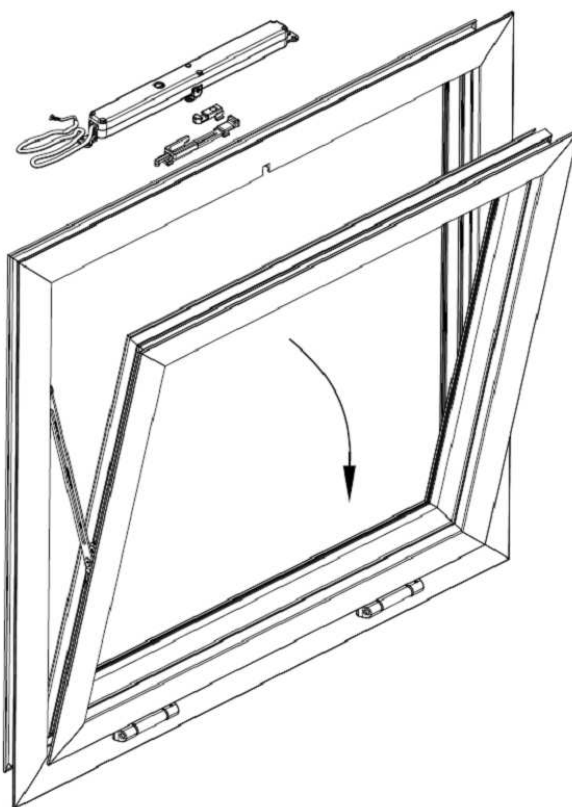

MANUALE D'USO E INSTALLAZIONE
USER AND INSTALLATION MANUAL
MANUAL DE USUARIO Y INSTALACIÓN



Il costruttore dispone dell'archivio tecnico che contiene la documentazione comprovante che i prodotti sono stati esaminati per la valutazione delle loro conformità alle direttive.

INDICE



1. Dati tecnici.....	pag. 4
2. Dati di targa e marchiatura	pag. 4
3. Formule e consigli per l'installazione.....	pag. 5
4. Costruzione e riferimenti normativi.....	pag. 5
5. Collegamento elettrico.....	pag. 5
6. Programmazione della corsa dell'attuatore.....	pag. 7

Simboli usati nel manuale

	PERICOLO	<i>Questa indicazione richiama l'attenzione su potenziali pericoli per l'incolumità e la salute delle persone e degli animali.</i>
	INFORMAZIONI	<i>Le informazioni forniscono ulteriori suggerimenti.</i>
	ATTENZIONE	<i>Questa indicazione richiama l'attenzione su potenziali pericoli per il prodotto.</i>
	AVVERTIMENTO	<i>Questa indicazione richiama l'attenzione su potenziali danni ai beni.</i>
	ISTRUZIONE AMBIENTALE	<i>L'istruzione ambientale richiama l'attenzione su potenziali pericoli per l'ambiente.</i>

Il sistema automatico **WiCloud**, descritto in questo manuale è destinato a movimentare finestre a Vasistas o simili. **L'uso per applicazioni diverse da quelle indicate, deve essere autorizzato dal costruttore, previa verifica tecnica del montaggio.**

INDICAZIONI GENERALI PER LA SICUREZZA

	<i>ATTENZIONE Prima d'iniziare l'installazione di questa macchina, leggere attentamente e comprendere le seguenti indicazioni di sicurezza.</i>
	<i>L'installazione dell'apparecchio ed eventuali riparazioni devono essere eseguite da personale tecnico competente e qualificato.</i>
	<i>Sacchetti di plastica, polistirolo, piccole minuterie metalliche quali chiodi, graffette, ecc. non devono essere lasciati alla portata dei bambini perché potenziali fonti di pericolo.</i>
	<i>L'apparecchio non è destinato a essere usato da persone (bambini compresi) le cui capacità fisiche, sensoriali o mentali siano ridotte, oppure con mancanza di esperienza o di conoscenza, a meno che esse abbiano potuto beneficiare, attraverso l'intermediazione di una persona responsabile della loro sicurezza, di una sorveglianza o di istruzioni riguardanti l'uso dell'apparecchio.</i>
	<i>Prima di collegare l'apparecchio, verificare che l'alimentazione elettrica da voi utilizzata abbia le stesse caratteristiche indicate nell'etichetta dati tecnici, applicata all'apparecchio.</i>
	<i>Questa macchina è destinata solo ed esclusivamente all'uso per il quale è stata concepita ed il costruttore non può essere ritenuto responsabile per danni dovuti ad un uso improprio.</i>
	<i>L'attuatore è destinato all'installazione interna. Per ogni applicazione speciale si raccomanda di consultare preventivamente il costruttore.</i>
	<i>Non lavare l'apparecchio con solventi o getti d'acqua. Non immergere l'apparecchio in acqua.</i>
	<i>Richiedere sempre ed esclusivamente l'impiego di ricambi originali. Il mancato rispetto di questa regola può compromettere la sicurezza ed annulla i benefici della garanzia applicata all'apparecchio.</i>
	<i>Su serramenti con apertura a vasistas c'è il pericolo di lesioni prodotte dalla caduta accidentale della finestra.</i>
	<i>Verificare che la selezione del fine corsa permetta l'apertura della finestra senza incontrare impedimenti di qualsivoglia natura.</i>
	<i>L'installazione dell'apparecchio va fatta seguendo le istruzioni del costruttore. Il mancato rispetto di tali raccomandazioni può compromettere la sicurezza. L'esecuzione dell'impianto elettrico d'alimentazione va eseguita nel rispetto delle norme in vigore.</i>
	<i>Pericolo di schiacciamento o di trascinamento. Durante il funzionamento, quando l'attuatore chiude il serramento, esso esercita una forza di 200N sulle battute dell'infisso; tale pressione è sufficiente a schiacciare le dita in caso di distrazione.</i>
	<i>Verificare che la selezione del fine corsa sia inferiore di almeno un centimetro al bloccaggio di fermi meccanici, limitatori di corsa oppure da eventuali impedimenti fisici all'apertura dell'anta.</i>
	<i>Nel caso di guasto o di mal funzionamento, spegnere l'apparecchio dall'interruttore generale e far intervenire un tecnico qualificato.</i>

WiCloud

1. DATI TECNICI

Modello	WiCloud
Forza di spinta e trazione	200 N
Corse	70, 125, 170, 210mm
Tensione d'alimentazione	24 V 
Assorbimento di corrente a carico nominale	0,32A
Potenza assorbita a carico nominale	7,5W
Velocità di traslazione a vuoto	8mm/s
Durata della corsa a vuoto (215 mm)	27 s
Tipo servizio	S ₂ di 3 min
Temperatura di funzionamento	- 5 + 65 °C
Grado di protezione dispositivi elettrici	IP32
Funzionamento tandem	Previsto
Funzionamento sincronizzato	NON previsto
Forza di tenuta statica	1000N
Fine corsa in apertura	Elettronico programmabile a dip-switch
Fine corsa in chiusura	Ad assorbimento di potenza
Lunghezza cavo di alimentazione	2m
Uscita catena	Centrale
Dimensioni	28x28x310mm
Peso apparecchio	0,660Kg

I dati tecnici riportati sopra non sono impegnativi e sono suscettibili di variazione anche senza preavviso

Scelta della sezione dei cavi d'alimentazione

Sezione dei cavi	Lunghezza max cavo
4,00 mm ²	~ 270 m
2,50 mm ²	~ 170 m
1,50 mm ²	~ 100 m
0,75 mm ²	~ 50 m
0,50 mm ²	~ 35 m

2. DATI DI TARGA E MARCHIATURA

I dati di targa sono riportati in un'etichetta adesiva in polietilene, applicata all'esterno del dispositivo. I valori sono conformi a quanto richiesto dalle norme comunitarie in vigore. L'immagine sotto riporta un esempio di etichetta.

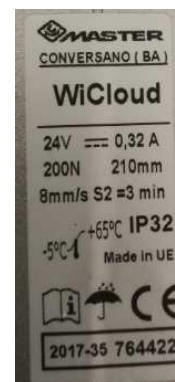

3. FORMULE E CONSIGLI PER L'INSTALLAZIONE

Calcolo della forza di apertura / chiusura

Simboli usati per il calcolo	
F (Kg) = Forza apertura o chiusura	P (Kg) = Peso della finestra (solo anta mobile)
C (cm) = Corsa d'apertura (corsa attuatore)	H (cm) = Altezza dell'anta mobile

▪ VASISTAS

$$F = 0,54 \times P \times C : H$$

(Il possibile carico di vento favorevole o contrario sull'anta, va considerato a parte).

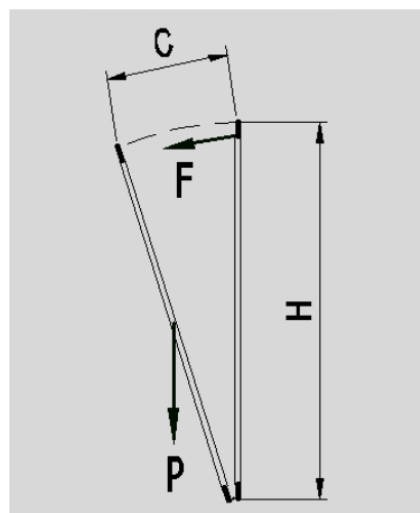

ATTENZIONE. L'attuatore è nato per essere montato ad incasso nel serramento. Verificare che durante la corsa la catena non tocchi il profilo dell'anta, che non ci siano ostacoli all'apertura o ci sia una forzatura della catena sul serramento.

4. COSTRUZIONE E RIFERIMENTI NORMATIVI

La struttura dell'attuatore è interamente in metallo costruito secondo le direttive dell'Unione Europea, è certificato in conformità con marchio CE. L'impianto elettrico deve rispettare le norme in vigore sulla progettazione e realizzazione.

5. COLLEGAMENTO ELETTRICO

L'alimentazione elettrica in bassa tensione 24V \equiv può avvenire da una centrale con batterie di emergenza oppure con un alimentatore omologato di classe II (*doppio isolamento di sicurezza*) avente tensione d'uscita di 24V \equiv (-15% ÷ +25%, cioè min. 20,4V, max. 30V).

L'alimentazione all'attuatore deve essere adeguatamente protetta da fusibili.



Il dispositivo richiede una tensione di 24V \equiv . Una tensione maggiore può distruggere il motore.

Schema elettrico collegamento pulsante 6 poli

- Nero "1", connesso al + (positivo) apre;
- Nero "2", connesso al + (positivo) chiude;
- Nero "3", non collegare per la funzione 'singolo'; collegare con il filo "3" dell'altro attuatore per la funzione 'tandem'.

Gli attuatori sono dotati di cavo di alimentazione a tre vie numerato della lunghezza di 2m direttamente collegato. Nell'immagine in basso lo schema di collegamento dell'alimentazione al pulsante.

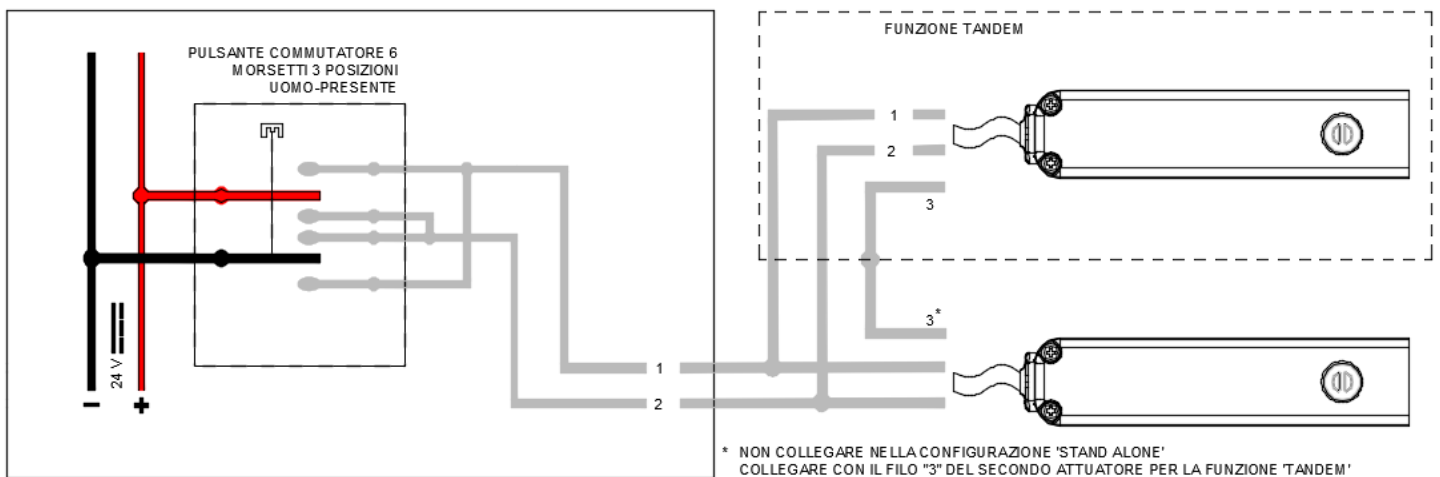

Schema elettrico collegamento con relè

- Nero "1", connesso al + (positivo) apre;
- Nero "2", connesso al + (positivo) chiude;
- Nero "3", non collegare per la funzione 'singolo'; collegare con il filo "3" dell'altro attuatore per la funzione 'tandem'.

Gli attuatori sono dotati di cavo di alimentazione a tre vie numerato della lunghezza di 2m direttamente collegato. Nell'immagine in basso lo schema di collegamento dell'alimentazione al pulsante.

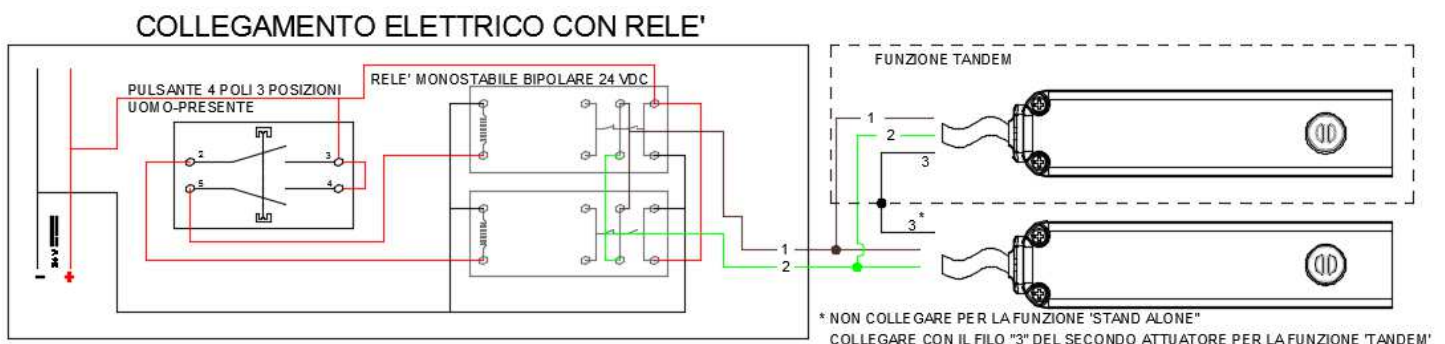

Di seguito le quote e le dimensioni in sezione dell'attuatore:

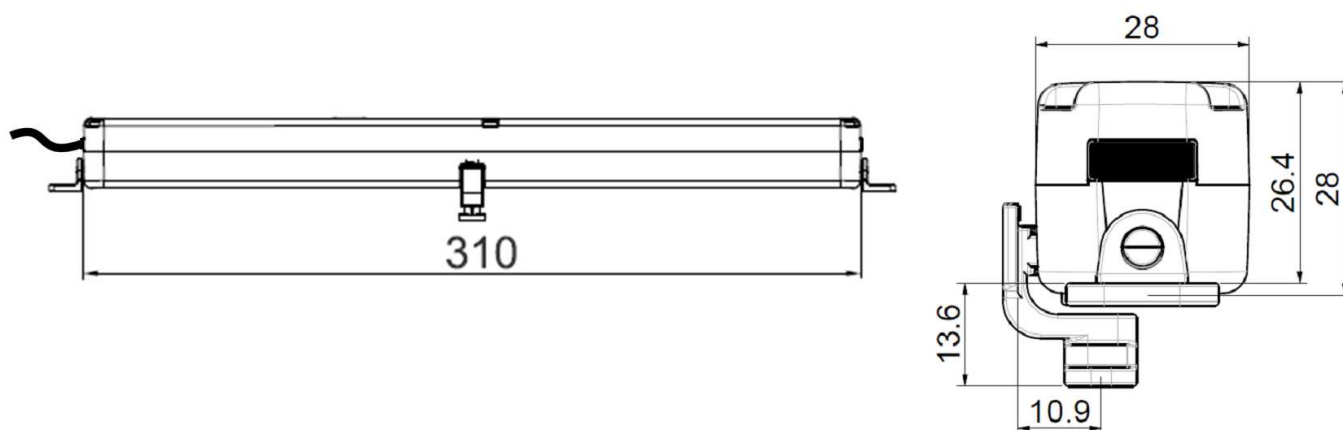

6. PROGRAMMAZIONE DELLA CORSA DELL'ATTUATORE

Fine corsa in apertura

Il fine corsa dell'attuatore in apertura, si regola con la selezione di 3 dip-switch (1, 2, 3) che si trovano all'interno dell'attuatore sotto il tappo nero di gomma (T) (vedi fig. sotto).

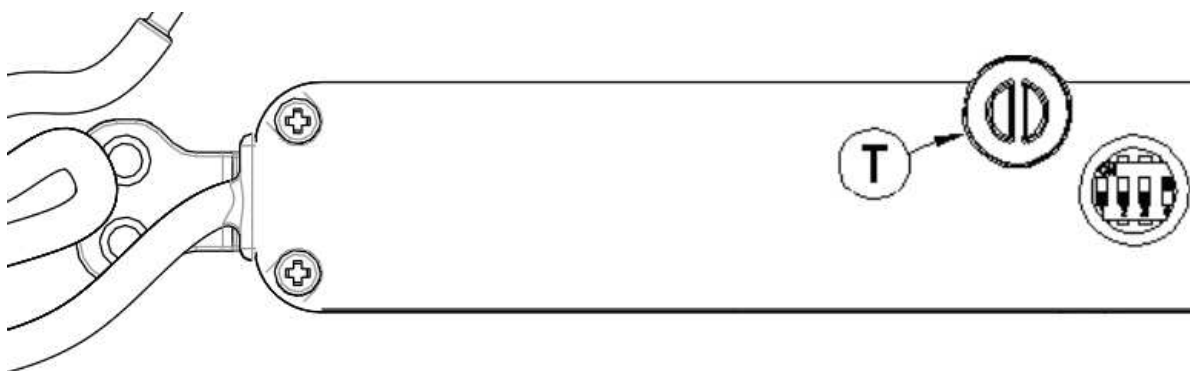

Significato dei dip-switch



- Funzionamento singolo

STROKE (mm)	DIP-SWITCH				H sash
	1	2	3	4	
70	ON	OFF	OFF	OFF	Min 500mm
125	OFF	ON	OFF	OFF	
160	OFF	OFF	ON	OFF	
210	OFF	OFF	OFF	OFF	

- Funzionamento Tandem

CORSA (mm)	DIP-SWITCH				H anta
	1	2	3	4	
70	ON	OFF	OFF	ON	Min 500mm
125	OFF	ON	OFF	ON	
160	OFF	OFF	ON	ON	
210	OFF	OFF	OFF	ON	

N.B.: Nel funzionamento Tandem i due attuatori devono avere le corse settate nelle medesime posizioni.

	<i>Nel caso in cui per errore si selezionano due o più dip-switch in ON, l'attuatore prende la corsa più corta selezionata.</i>
	Attenzione. L'attuatore viene fornito con corsa minima 70mm.

Fine corsa in chiusura



Il fine corsa in chiusura è automatico e non programmabile.

L'arresto dell'attuatore avviene per effetto dell'assorbimento di potenza (potenza assorbita + 15% di quella nominale). Dopo ogni chiusura o intervento della protezione elettronica, la catena si muove in senso contrario per circa 1mm, per dare la giusta compressione alle guarnizioni e rilassare gli organi meccanici interni.

Montaggio dell'attuatore nel serramento

Prima di montare l'attuatore nel serramento verificare di:

- aver fatto passare tutti i cavi necessari alle connessioni, attraverso le opportune lavorazioni in modo da seguire il percorso ideale;
- aver selezionato la corsa.

	<i>Attenzione. Verificare che non vi siano dei fili che si toccano tra loro; potrebbero causare dei danni alle macchine del sistema.</i>
	<i>Prima di montare l'attuatore nel serramento, collegare l'alimentazione e programmare il fine corsa in apertura; una volta montato non è possibile agire sui dip-switch perché sono nascosti.</i>

CONCLUSIONI

- Connettere il cavo di alimentazione dell'attuatore a catena e selezionare la corsa.
- Montare l'attuatore ad incasso nel foro fatto in precedenza avendo particolare cura di non rovinare i cavi, spostandolo prima verso un lato e poi centrandolo nei fori di fissaggio.
- Eseguire una prova di collaudo e verificare che il dispositivo agisca correttamente sul serramento.
- Verificare che una volta installato il prodotto, il gancio di presa dell'accessorio scorrevole sia perfettamente agganciato quando l'attuatore è chiuso.

PROTEZIONE AMBIENTALE

	<p>Tutti i materiali utilizzati per la costruzione della macchina sono riciclabili.</p> <p>Si raccomanda che la macchina stessa, accessori, imballi, ecc. siano inviati ad un centro per il riutilizzo ecologico come stabilito dalle leggi vigenti in materia di riciclaggio dei rifiuti.</p> <p>Componenti dell'apparecchio:</p> <p><input checked="" type="checkbox"/> Ferro <input checked="" type="checkbox"/> Alluminio <input checked="" type="checkbox"/> Rame <input checked="" type="checkbox"/> Zinco <input checked="" type="checkbox"/> Silicio <input checked="" type="checkbox"/> Plastica</p>
--	--

RICHIAMO AI PRINCIPI DEL CERTIFICATO DI GARANZIA

	<p>Il costruttore si rende garante del buon funzionamento della macchina. S'impegna ad eseguire la sostituzione dei pezzi difettosi per cattiva qualità del materiale o per difetti di costruzione secondo quanto stabilito dall'articolo 1490 del Codice Civile.</p> <p>La garanzia copre i prodotti o le singole parti per un periodo di 2 anni dalla data d'acquisto. La stessa è valida se l'acquirente sia stato in grado di esibire la prova d'acquisto ed abbia soddisfatto le condizioni di pagamento pattuite.</p> <p>La garanzia di buon funzionamento degli apparecchi accordata dal costruttore, s'intende nel senso che lo stesso s'impegna a riparare o sostituire gratuitamente, nel più breve tempo possibile, quelle parti che dovessero guastarsi durante il periodo di garanzia. L'acquirente non può vantare diritto ad alcun risarcimento per eventuali danni, diretti o indiretti, o altre spese. Tentativi di riparazione da parte di personale non autorizzato dal costruttore fanno decadere la garanzia.</p> <p>Sono escluse dalla garanzia le parti fragili o esposte a naturale usura come pure ad agenti o procedimenti corrosivi, a sovraccarichi anche se solo temporanei, ecc. Il costruttore non risponde per eventuali danni causati da errato montaggio, manovra o inserzione, da eccessive sollecitazioni o da imperizia d'uso.</p> <p>Le riparazioni in garanzia sono sempre da intendersi "franco fabbrica produttore".</p> <p>Le spese di trasporto relative (andata / ritorno) sono sempre a carico dell'acquirente.</p> <p>La rimozione completa o parziale dell'etichetta adesiva (riportante i dati di targa) fa decadere la garanzia. Prima della richiesta di intervento tecnico autorizzato, l'acquirente deve accertarsi che il cavo di alimentazione originale sia presente e che abbia una lunghezza non inferiore a 30cm.</p>
---	---







The manufacturer has the technical file that contains the documentation attesting that the products have been examined for evaluation of their compliance with the directives.

CONTENTS















1. Technical data.....	page 12
2. Rating and marking	page 12
3. Formulas and recommendations for installation.....	page 13
4. Construction and regulatory references.....	page 13
5. Electrical connection.....	page 13
6. Setting the stroke of the actuator.....	page 15

Symbols used in the manual

	HAZARD	<i>This indication calls the reader's attention to potential hazards for the health and well-being of people and animals.</i>
	INFORMATION	<i>The information provides further suggestions.</i>
	CAUTION	<i>This indication calls the reader's attention to potential hazards for the product.</i>
	WARNING	<i>This indication calls the reader's attention to potential damage to goods.</i>
	ENVIRONMENTAL INSTRUCTION	<i>The environmental instruction calls the reader's attention to potential hazards for the environment.</i>

The automatic system **WiCloud** described in this manual is intended to move awning/hopper windows or the like. **Any use for applications other than those indicated must be authorized by the manufacturer upon technical verification of the assembly.**

GENERAL SAFETY GUIDELINES

	<i>CAUTION Before beginning to install this machine, carefully read and understand the following safety guidelines.</i>
	<i>The installation of the device and any repairs must be carried out by skilled and qualified technical personnel.</i>
	<i>Plastic bags, polystyrene, small metal parts such as nails, staples, etc. must not be left within the reach of children as they represent potential hazards.</i>
	<i>The device is not intended to be used by persons (including children) whose physical, sensory or mental abilities are reduced or who lack the necessary experience or knowledge, unless a person responsible for their safety provides supervision or instructions concerning the use of the device.</i>
	<i>Before connecting the device, check that the electric power supply used has the same characteristics indicated on the technical data label, attached to the device.</i>
	<i>This machine is intended only and exclusively for the use for which it was designed, and the manufacturer cannot be held liable for damage due to improper use.</i>
	<i>The actuator is designed for internal installation. For any special application, it is highly recommended that you consult the manufacturer in advance.</i>
	<i>Do not wash the device with solvents or water jets. Do not submerge the device in water.</i>
	<i>Always request the use of original spare parts only. Failure to observe this rule may compromise safety and void the warranty applied to the device.</i>
	<i>Hopper windows present the hazard of injuries caused by the accidental fall of the window.</i>
	<i>Check that the selected stroke-end allows the window to open without encountering any obstacles whatsoever.</i>
	<i>The device must be installed following the manufacturer's instructions. Failure to observe these recommendations may compromise safety. The electrical power supply system must be designed and implemented in compliance with current standards.</i>
	<i>Crushing or dragging hazard. During operation, when the actuator closes the window, it exerts a force of 200N on the stops of the fixture; this pressure is enough to crush your fingers in case of distraction.</i>
	<i>Check that the selected stroke-end is at least one centimeter from mechanical stops, stroke limiters or any physical obstacles to the opening of the sash.</i>
	<i>In the event of a failure or malfunction, switch the device off using the power switch and call a qualified technician.</i>

WiCloud

1. TECHNICAL DATA

<i>Model</i>	<i>WiCloud</i>
Compression and tensile force	200 N
Strokes	70, 125, 170, 210mm
Power supply voltage	24 V 
Current absorbed at nominal load	0.32A
Power absorbed at nominal load	7.5W
No-load traverse speed	8mm/s
No-load stroke time (215 mm)	27 s
Service type	S ₂ of 3 min
Operating temperature	- 5 + 65 °C
Degree of protection for electrical devices	IP32
Tandem operation	Provided for
Synchronized operation	NOT provided for
Static seal strength	1000N
Opening stroke-end	Electronic, set by dip-switches
Closing stroke-end	By power absorption
Power supply cable length	2m
Chain outlet	Central
Dimensions	28x28x310mm
Device weight	0.660kg

The technical data provided above is non-binding and subject to change, even without advance notice.

Selecting the cross-section of the power supply cables

<i>Cable cross section</i>	<i>Max cable length</i>
4.00 mm ²	~ 270 m
2.50 mm ²	~ 170 m
1.50 mm ²	~ 100 m
0.75 mm ²	~ 50 m
0.50 mm ²	~ 35 m

2. RATING AND MARKING

The rating data is provided on an adhesive polyethylene label attached to the exterior of the device. The values are compliant with that required by the EC standards in force. An example of the label is shown in the photo below.



3. FORMULAS AND RECOMMENDATIONS FOR INSTALLATION

Calculation of the opening / closing force

<i>Symbols used for the calculation</i>	
F (kg) = opening or closing force	P (kg) = Weight of the window (movable sash only)
C (cm) = opening stroke (actuator stroke)	H (cm) = Height of the movable sash

▪ HOPPER

$$F = 0.54 \times P \times C : H$$

(Any wind load, favorable or unfavorable on the sash, should be considered separately).

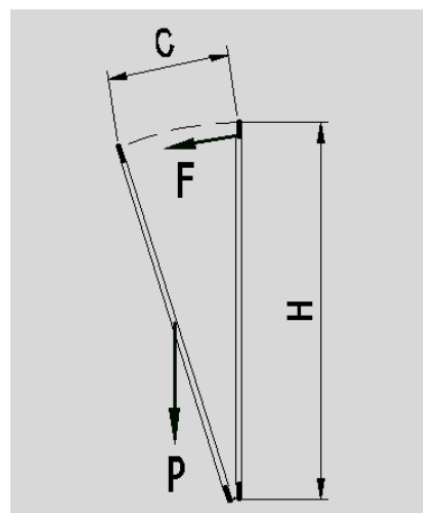

WARNING. *The actuator is designed to be recess mounted on the window frame. Check that during the stroke the chain does not touch the profile of the sash, there are no obstacles to opening the window and the chain does not push against the window frame.*

4. CONSTRUCTION AND REGULATORY REFERENCES

The structure of the actuator is made entirely of metal, constructed according to European Union directives and certified in conformity with the CE mark. The electrical system must meet current standards on design and implementation.

5. ELECTRICAL CONNECTION

The 24V low-voltage electric power supply === can be achieved using a station with emergency batteries or an approved class II power supply unit (*double safety insulation*) with an output voltage of 24V === (-15% ÷ +25%, in other words min. 20.4V, max. 30V).

The power supply to the actuator must be suitably protected by fuses.



The device requires a voltage of 24V === . A higher voltage may destroy the motor.

6-pin switch connection wiring diagram

- Black “1”, connected to the + (positive) open;
- Black “2”, connected to the + (positive) close;
- Black “3”, do not connect for ‘stand alone’ operation; connect with black “3” of second actuator for ‘Tandem’ operation.

The actuators are equipped with a numbered three-way power supply cable with a length of 2m connected directly to the device. The diagram for connecting the power supply to the switch is provided below.

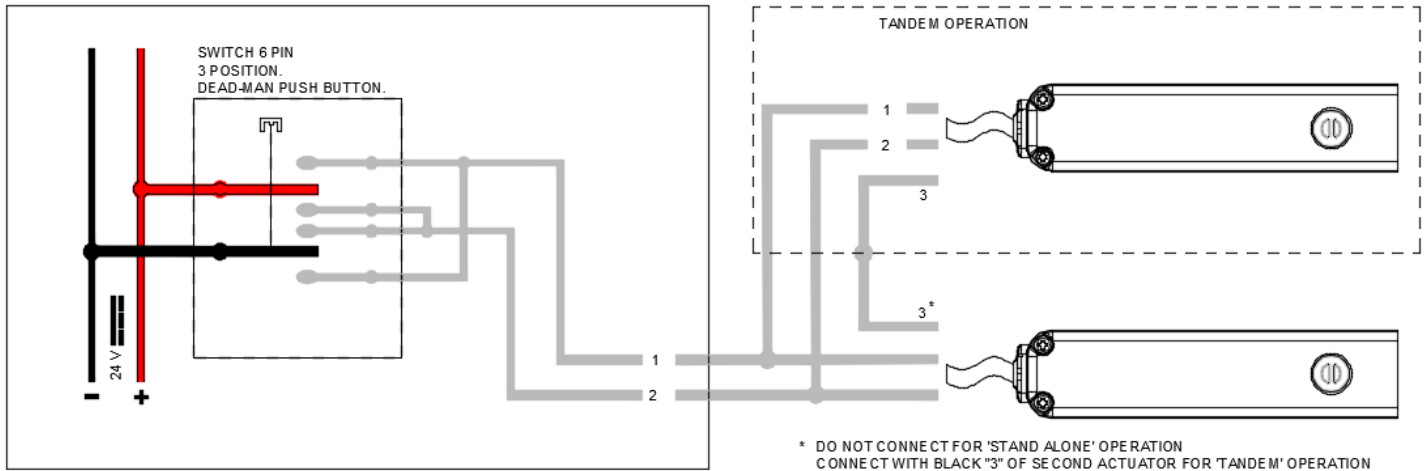

Connection wiring diagram with relay

- Black “1”, connected to the + (positive) open;
- Black “2”, connected to the + (positive) close;
- Black “3”, do not connect for ‘stand alone’ operation; connect with black “3” of second actuator for ‘Tandem’ operation.

The actuators are equipped with a numbered three-way power supply cable with a length of 2m connected directly to the device. The diagram for connecting the power supply to the switch is provided below.

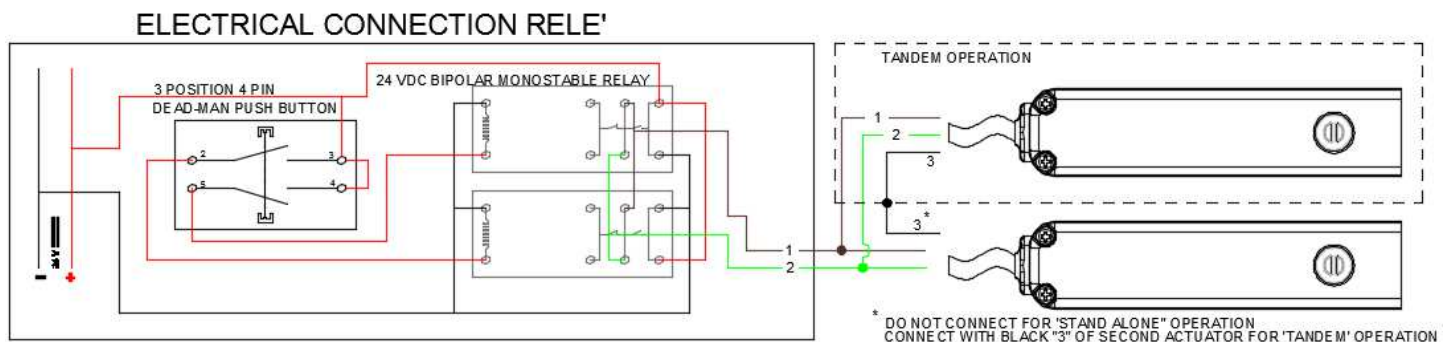

The diagram below specifies the length and cross-section dimensions of the actuator:

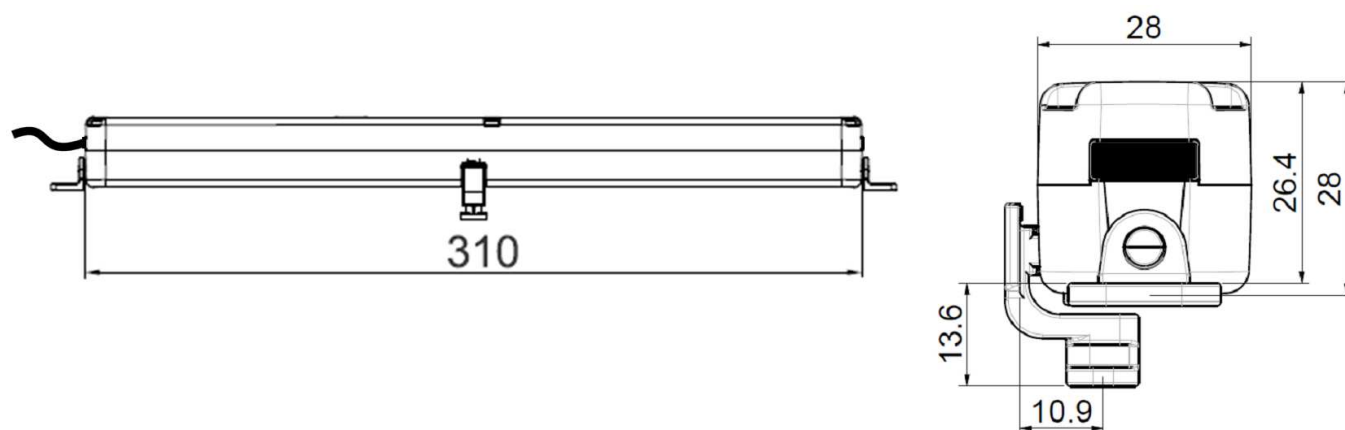

6. SETTING THE STROKE OF THE ACTUATOR

Opening stroke-end

The opening stroke-end of the actuator can be adjusted by selecting the 3 dip-switches (1, 2, 3) located inside the actuator underneath the black rubber plug (T) (see fig. below).

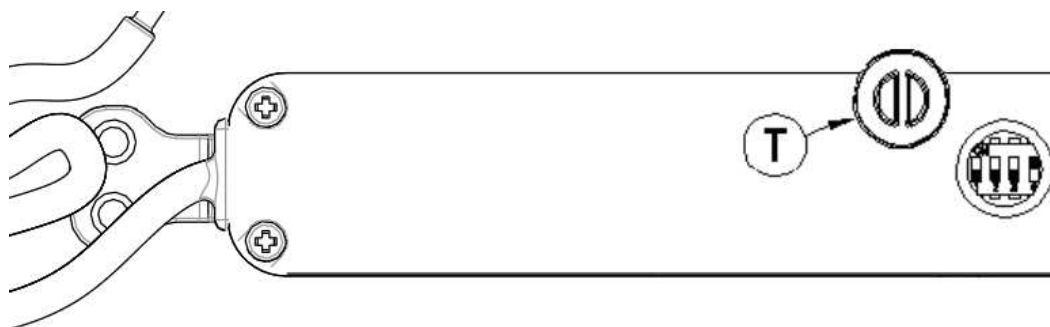

Meaning of the dip-switches



- 'Stand alone' operation

STROKE (mm)	DIP-SWITCH				H sash
	1	2	3	4	
70	ON	OFF	OFF	OFF	Min 500mm
125	OFF	ON	OFF	OFF	
160	OFF	OFF	ON	OFF	
210	OFF	OFF	OFF	OFF	

- 'Tandem' operation

CORSA (mm)	DIP-SWITCH				H anta
	1	2	3	4	
70	ON	OFF	OFF	ON	Min 500mm
125	OFF	ON	OFF	ON	
160	OFF	OFF	ON	ON	
210	OFF	OFF	OFF	ON	

N.B.: For 'Tandem' operation the actuators must have the same dip-switches set.

	<i>If two or more dip-switches are accidentally set to ON, the actuator uses the shortest of the selected strokes.</i>
	Attention. <i>The actuator is supplied with a minimum stroke 70mm.</i>

Closing stroke-end



The closing stroke-end is automatic and non-settable.

The stop of the actuator is determined by the power absorbed (power absorbed + 15% of the nominal value). After each closure or intervention of the electronic protection, the chain moves in the opposite direction by about 1mm in order to produce the right compression on the gaskets and relax the internal mechanical parts.

Assembly of the actuator on the window frame

Before assembling the actuator on the window frame, check that:

- all the cables needed for connections have been passed through the appropriate millings so as to follow the ideal path;
- the stroke has been selected.

	<i>Caution. Check that there are no wires touching one another; this could damage the machines of the system.</i>
	<i>Before assembling the actuator on the window frame, connect the power supply and set the opening stroke-end; once the actuator is assembled, it is no longer possible to operate the dip-switches since they are hidden.</i>

CONCLUSIONS

- Connect the power supply cable of the chain actuator and select the stroke.
- Recess mount the actuator in the hole made previously, taking particular care not to ruin the cables, moving it first towards one side and then centering it on the fastening holes.
- Perform a final test and verify that the device operates correctly on the window frame.
- Check that once the product is installed, the gripping hook of the sliding accessory is completely hooked when the actuator is closed.

ENVIRONMENTAL PROTECTION

	<p>All the materials used for construction of the machine are recyclable.</p> <p>It is recommended that the machine itself, the accessories, packing materials, etc. be sent to a recycling center as required by current laws on waste recycling.</p> <p>Components of the device:</p> <p><input checked="" type="checkbox"/> Iron <input checked="" type="checkbox"/> Aluminum <input checked="" type="checkbox"/> Copper <input checked="" type="checkbox"/> Zinc <input checked="" type="checkbox"/> Silicon <input checked="" type="checkbox"/> Plastic</p>
--	--

REFERENCE TO THE PRINCIPLES OF THE WARRANTY CERTIFICATE

	<p>The manufacturer guarantees good operation of the machine. The manufacturer also undertakes to replace pieces that are defective due to poor quality of the material or manufacturing defects as set forth in article 1490 of the Italian Civil Code.</p> <p>The warranty covers the products or individual parts for a period of 2 years from the date of purchase. The warranty is valid if the buyer is able to exhibit proof of purchase and has met the agreed payment terms and conditions.</p> <p>The guarantee of good operation of the devices granted by the manufacturer is understood in the sense that the manufacturer undertakes to repair or replace, free of charge and in the shortest time possible, those parts that have failed during the warranty period. The buyer cannot claim right to any compensation for any direct or indirect damages or other expenses. Any repair attempts made by personnel who have not been authorized by the manufacturer void the warranty.</p> <p>Fragile parts or parts subject to natural wear, corrosive agents or procedures, excessive loads (even if only temporary), etc., are not covered by the warranty. The manufacturer will not be held liable for any damage caused by incorrect assembly, handling or insertion, excessive stress or inexperienced use.</p> <p>The repairs under warranty are always understood to be "ex-factory". The buyer must always pay the respective shipping expenses (to and from the factory).</p> <p>The total or partial removing of the sticker label (with the identification code of the article) invalidates the warranty.</p> <p>Before the intervention of an authorized technician, the buyer has to prove the presence of the original power cable, that must be no shorter than 30 cm.</p>
---	---







El fabricante tiene el archivo técnico que contiene la documentación. que acredite que los productos han sido examinados para su evaluación de su cumplimiento de las directivas.

CONTENTS















1. Información técnica.....	página 20
2. Medidas y marcaje.....	página 21
3. Fórmulas y recomendaciones para la instalación	página 21
4. Construcción y referencias de regulación	página 22
5. Conexión eléctrica.....	página 22
6. Instalando la guía del actuador.....	página 23

Símbolos usados en el manual

	PELIGRO	<i>Esta indicación llama la atención del lector de posibles peligros para la salud y el bienestar de gente y animales.</i>
	INFORMACIÓN	<i>La información provee más sugerencias.</i>
	PRECAUCIÓN	<i>Esta indicación llama la atención del lector de posibles peligros para el producto.</i>
	ADVERTENCIA	<i>Esta indicación llama la atención del lector de posibles peligros para el bienestar.</i>
	INSTRUCCIONES MEDIOAMBIENTALES	<i>Las instrucciones medioambientales llaman la atención del lector de posibles peligros para el medioambiente.</i>

El sistema automático WiCloud descrito en este manual tiene la intención de mover el toldo/aro de la ventana o similar. Cualquier uso para las aplicaciones distinto de los indicados debe ser autorizado por el fabricante sobre la verificación técnica de la asamblea.

INSTRUCCIONES GENERALES DE SEGURIDAD

	<i>PRECAUCIÓN Antes de empezar a instalar esta máquina, lea con atención y entienda la siguiente guía de seguridad.</i>
	<i>La instalación del aparato y cualquier reparación debe ser llevada a cabo por personal técnico dotado y cualificado.</i>
	<i>La bolsas de plástico, poliestireno, pequeñas partes metálicas como clavos, tornillos, etc. no deben dejarse al alcance de los niños ya que presentan posibles peligros.</i>
	<i>Este aparato no está pensado para ser usado por personas (niños incluidos) cuyas habilidades físicas, mentales o sensoriales son reducidas o por aquellas que tengan una falta de experiencia o conocimiento, a menos que una persona responsable de su seguridad provee supervisión o instrucciones (ASKJD-FA) el uso del aparato</i>
	<i>Antes de conectar el aparato, asegúrese de que la fuente de energía eléctrica usada tiene las mismas características indicadas en la etiqueta de información técnica, pegada en el aparato.</i>
	<i>Esta maquina está hecha única y exclusivamente para el uso para el cual ha sido diseñada, y el fabricante no puede hacerse responsable por daños causados por un uso inapropiado.</i>
	<i>El actuador está diseñado para la instalación interna. Para cualquier aplicación especial, es muy recomendable que consulte el fabricante por avanzado.</i>
	<i>No lave el aparato con disolventes o chorros de agua. No sumerja el aparato en agua.</i>
	<i>Siempre es requerido el uso de las partes sobrantes. No observar esta regla puede comprometer la seguridad y anular la garantía aplicada en este aparato.</i>
	<i>La ventanas con toldos presentan peligro de daño causado por la caída accidental de una ventana.</i>
	<i>Asegúrese de que el final de la guía seleccionada permite que la ventana se abra sin encontrarse ningún obstáculo que se lo impida.</i>
	<i>El aparato debe ser instalado siguiendo las instrucciones de fabricante. No observar estas recomendaciones puede comprometer la seguridad. La fuente de energía eléctrica debe ser diseñada e implementada en concordancia con los actuales estándares.</i>
	<i>Peligro de rotura. Durante la operación, cuando el actuador cierra la ventana, ejerce una fuerza de 200N en el tope de la fijadura; esta presión es la suficiente como para romper sus dedos en caso de distracción.</i>
	<i>Asegúrese de que el final de la guía seleccionada está al menos a un centímetro de la parada mecánica, de los limitadores de la guía o de cualquier obstáculo físico.</i>
	<i>En el caso de malfunción o fallo, apague el aparato usando el interruptor de encendido y llama a un técnico cualificado.</i>

WiCloud

1. INFORMACIÓN TÉCNICA

Modelo	WiCloud
Compresión y fuerza de tensión	200 N
Guía	70, 125, 170, 210m
Voltage de la fuente de energía	24V
Corriente absorbida en carga nominal	0,32A
Energía absorbida en carga nominal	7,5W
Velocidad de cruce en no-carga	8mm/s
Tiempo de guía en no-carga (215mm)	S2 de 3 min
Temperatura de operación	-5 + 65°C
Grado de protección para aparatos eléctricos	IP32
Operación de tandem	Preparado
Operación sincronizada	No preparado
Fuerza estática del cierre	1000N
Abertura del final de guía	Electrónica, establecido por interruptor
Cerradura del final de guía	Por absorción de energía
Longitud del cable de corriente	2m
Toma de cadena	Central
Dimensiones	28x28x310mm
Peso del aparato	0,660Kg

La información técnica proporcionada arriba no puede ser legalmente sujeta a cambios, incluso con aviso previo.

Seleccionando la sección de cruce de los cables de la fuente de energía

Sección de cruce de cables	Máxima largaria del cable
4,00 mm ²	270m
2,50 mm ²	170m
1,50 mm ²	100m
0,75 mm ²	50m
0,50 mm ²	25m

2.MEDIDAS Y MARCAJE

La información de medidas está incorporada en una etiqueta adhesiva de poliéstileno pegada en el exterior del aparato. Los valores cumplen con los requeridos por los estándares de EC a cargo. Un ejemplo de la etiqueta debajo.

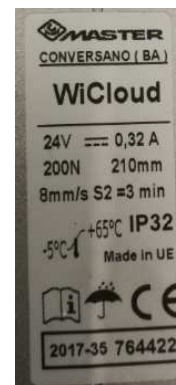

3.FÓRMULAS Y RECOMENDACIONES PARA LA INSTALACIÓN

Cálculo de la fuerza de abertura/cierre

Símbolos usados para el cálculo	
F (Kg) = fuerza de abertura o cierre	P (Kg) = Peso de la ventana
C (cm) = guía de abertura (guía del actuador)	H (cm) = Altura de la guillotina móvil

· TOLVA

$$F = 0,54 \times P \times C : H$$

(Cualquier cargamento de viento, favorable o desfavorable para la guillotina, debe ser considerado aparte.)

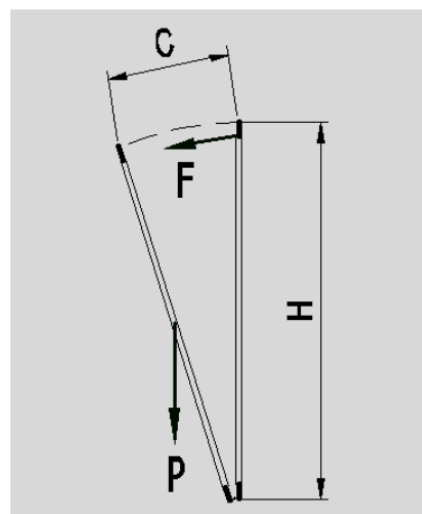

ADVERTENCIA. El actuador está diseñado para recreadamente montado en el marco de la ventana. Compruebe que durante el golpeado la cadena no toca el perfil de la guillotina, que no haya obstáculos para abrir la ventana y que la cadena empuje contra el perfil de la ventana.

4. CONSTRUCCIÓN Y REFERENCIAS DE REGULACIONES

La estructura del regulador está hecha completamente de metal, construida de acuerdo con las directivas de la Unión Europea y certificada conforme la marca . El sistema eléctrico manual debe cumplir los estándares actuales en el diseño y en la ejecución.

5. CONEXIÓN ELÉCTRICA

La fuente de energía eléctrica de bajo voltaje de 24V puede ser conseguida usando una estación con baterías de emergencia o una fuente de energía aprobada de clase II (doble aislamiento de seguridad) con un voltaje de salida de 24V (-15% " +25%, en otras palabras, min. 20,4V, max. 30V.)

La fuente de energía del actuador debe de ser protegida apropiadamente por fusibles.



El aparato requiere un voltaje de 24V. Un mayor voltaje puede destruir el motor.

Diagrama del cambio de broche de la instalación eléctrica

- Negro "1", conectado con el + (positivo) abierto;
- Negro "2", conectado con el + (positivo) cerrado;
- Negro "3", no conectar para la operación "stand alone"; conectar con negro "3" del segundo operador para la operación "tandem".

Los actuadores están equipados con un cable de alimentación numerado de tres partes con una largada de 2m conectado directamente con el aparato. El diagrama para conectar el cable de alimentación con el interruptor se muestra debajo.

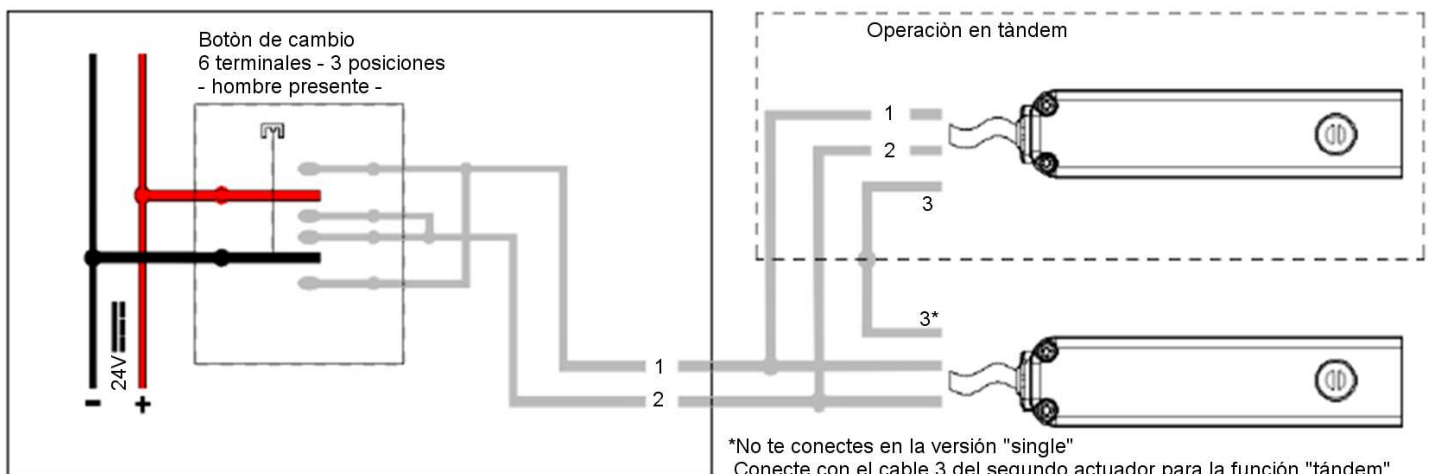

Conexión de la instalación eléctrica con relé

- Negro "1", conectado con el + (positivo) abierto;
- Negro "2", conectado con el + (positivo) cerrado;
- Negro "3", no conectar para la operación "stand alone"; conectar con negro "3" del segundo operador para la operación "tándem".

Los actuadores están equipados con un cable de alimentación numerado de tres partes con una largada de 2m conectado directamente con el aparato. El diagrama para conectar el cable de alimentación con el interruptor se muestra debajo.

Conexión eléctrica con relé

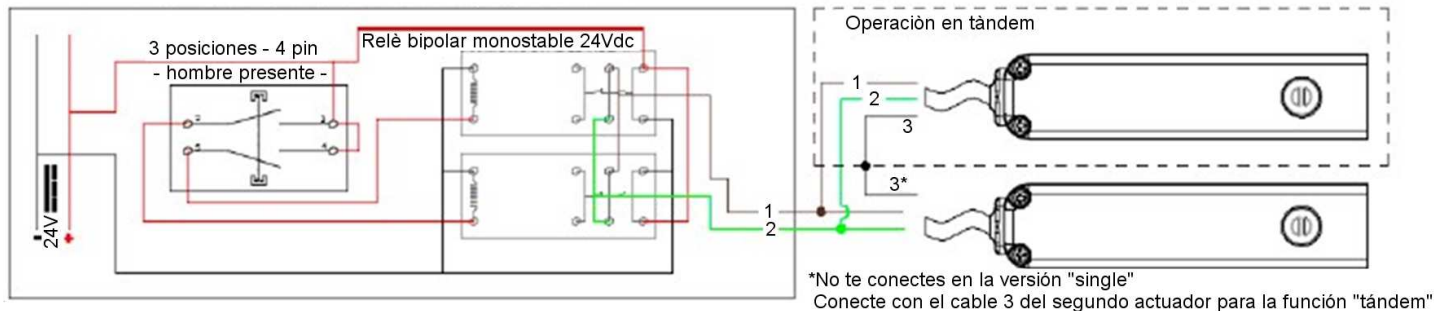

El diagrama de debajo especifica la largada y las dimensiones de la sección de cruce del actuador:

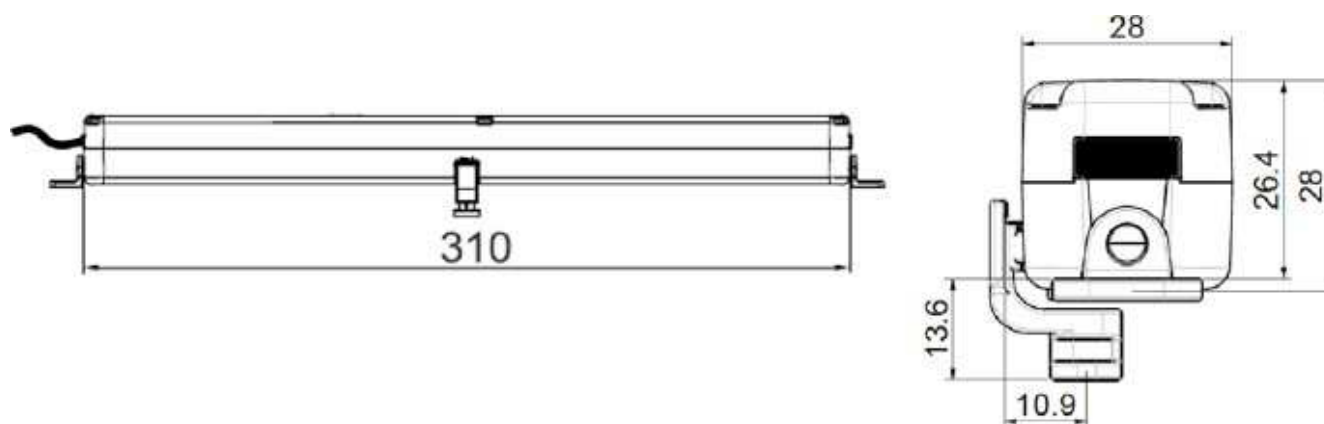

6. INSTALANDO LA GUÍA DEL ACTUADOR

Abertura del final de la guía

El interruptor de límite de apertura del actuador se ajusta seleccionando 3 interruptores (1.2.3) que están ubicados dentro del actuador debajo de la tapa de goma negra (T).

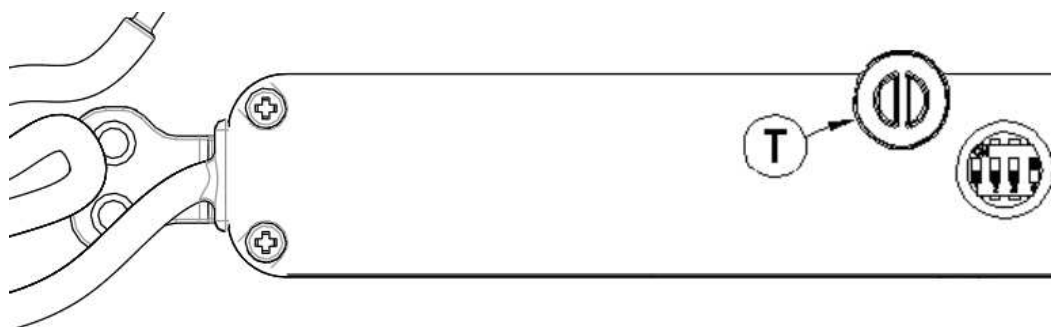

Operación "stand alone".



"DIP-SWITCH": Interruptor (o conmutador de luces).

STROKE (mm)	DIP-SWITCH				H sash
	1	2	3	4	
70	ON	OFF	OFF	OFF	Min 500mm
125	OFF	ON	OFF	OFF	
160	OFF	OFF	ON	OFF	
210	OFF	OFF	OFF	OFF	

Operación "Tandem".

CORSA (mm)	DIP-SWITCH				H anta
	1	2	3	4	
70	ON	OFF	OFF	ON	Min 500mm
125	OFF	ON	OFF	ON	
160	OFF	OFF	ON	ON	
210	OFF	OFF	OFF	ON	

N.B: Para la operación "Tandem" los actuadores deben tener el mismo ajuste  (interruptor).

	Si dos o más interruptores son cambiados a "ON" accidentalmente, el  usa la guía más pequeña.
	ATENCIÓN. El actuador está suministrado con una guía mínima de 70mm.

Cerradura del final de la guía



La cerradura del final de la guía es automática y no programable.

El tope del actuador está determinado por la energía absorbida (energía absorbida +15% del valor nominal). Después de cada cierre o intervención de la protección electrónica, la cadena se mueve en la dirección opuesta al menos 1mm con la función de producir la compresión correcta en la goma y relaja las partes mecánicas internas.

Colocacòn del actuador en el marco de la ventana

Antes de colocar el actuador en el marco de la ventana, compruebe esto:

- Todos los cables necesarios para las conexiones han pasado por la fundidora apropiada para seguir la trayectoria ideal;
- La guía ha estado seleccionada.

	ATENCIÓN. Compruebe que no hay cables tocándose unos a otros; esto  dañar la maquinaria del sistema.
	Antes de colocar el actuador en el marco de la ventana, conecte el cable de alimentación y programe el final de la guía; una vez colocado el actuador, ya no es posible operar los interruptores, ya que quedan escondidos.

CONCLUSIONES

- Conecte el cable de alimentación del actuador de cadena y seleccione la carrera..
- Coloque el actuador en el orificio en el orificio realizado anteriormente, teniendo especial cuidado de no arruinar los cables, moviéndolo primero hacia un lado y luego centrando en los orificios de fijación..
- Realice una prueba final y verifique que el dispositivo funcione correctamente en el marco de la Ventana
- Verifique que una vez que se haya instalado el producto, el gancho de sujeción del accesorio deslizante esté completamente enganchado cuando el actuador esté cerrado.

ENVIRONMENTAL PROTECTION



Todos los materiales utilizados para la construcción de la máquina son reciclables. Se recomienda que la máquina, los accesorios, los materiales de embalaje, etc. se envíen a un centro de reciclaje como lo requieren las leyes vigentes sobre reciclaje de residuos.

Componentes del dispositivo:

Planchar Aluminio Cobre Zinc Silicona Plàstico

REFERENCE TO THE PRINCIPLES OF THE WARRANTY CERTIFICATE



El fabricante garantiza un buen funcionamiento de la máquina. El fabricante también se compromete a reemplazar las piezas defectuosas debido a la mala calidad del material o los defectos de fabricación establecidos en el artículo 1490 del Código Civil italiano. La garantía cubre los productos o piezas individuales por un período de 2 años a partir de la fecha de compra. La garantía es válida si el comprador puede exhibir la prueba de compra y ha cumplido con los términos y condiciones de pago acordados.

La garantía de buen funcionamiento de los dispositivos otorgados por el fabricante se entiende en el sentido de que el fabricante se compromete a reparar o reemplazar, de forma gratuita y en el menor tiempo posible, aquellas piezas que hayan fallado durante el período de garantía. El comprador no puede reclamar el derecho a ninguna compensación por daños directos o indirectos u otros gastos. Cualquier intento de reparación realizado por personal no autorizado por el fabricante anulará la garantía.

Las piezas frágiles o las piezas sujetas a desgaste natural, agentes o procedimientos corrosivos, cargas excesivas (aunque solo sean temporales), etc., no están cubiertas por la garantía. El fabricante no será responsable por ningún daño causado por un montaje, manejo o inserción incorrectos, estrés excesivo o uso inexperto.

Las reparaciones en garantía siempre se entienden como "en fábrica". El comprador siempre debe pagar los gastos de envío respectivos (desde y hacia la fábrica).

La eliminación total o parcial de la etiqueta adhesiva (con el código de identificación del artículo) invalida la garantía.

Antes de la intervención de un técnico autorizado, el comprador debe demostrar la presencia del cable de alimentación original, que no debe ser inferior a 30 cm.

